

WR-12 to WR-15 Waveguide Transition 1 Inch Length Using UG-387/U to UG-385/U Flange

The SMW12TS15001 is part of Fairview's family of Waveguide Transitions (also sometimes called waveguide adapters) used as a means of propagating RF/Microwave energy from one waveguide size to another. The SMW12TS15001 allows the waveguide to change from a WR-12 waveguide (using a UG-387/U flange) to a WR-15 waveguide (using a UG-385/U flange.) The waveguide body has a plated gold finish.

Electrical Specifications

Description	Min	Typ	Max	Units
VSWR			1.2:1	
Insertion Loss			0.75	dB

Mechanical Specifications

Size	
Length	1 in [25.4 mm]
Weight	0.07 lbs [31.75 g]

Description	Flange 1	Waveguide	Flange 2
Interface	UG-387/U	WR-12 to WR-15	UG-385/U
Material	Brass	Brass	Brass
Plating	Gold	Gold	Gold
Plating Spec.	ASTMB488	ASTMB488	ASTMB488
Finish	Gold	Gold	Gold

Compliance Certifications (visit www.FairviewMicrowave.com for current document)

RoHS Compliant	Yes
REACH Compliant	12/17/2015

Plotted and Other Data

Notes:

- Typical VSWR/Return Loss data taken with load.
- Typical insertion loss data taken for two parts in series. The WR-15 flanges are connected together and the WR-12 flanges are connected to the test equipment.



Features:

- WR-12 to WR-15 waveguide
- WR-12 waveguide UG-387/U flange
- WR-15 waveguide UG-385/U flange
- Gold plated finish
- Precision manufactured

Applications:

- Radar Systems
- Military and Space
- Wireless Radio Systems
- Telecom Infrastructure
- Communication Systems
- R&D Labs
- Microwave Radio Systems

Fairview Microwave
 1130 Junction Dr. #100
 Allen, TX 75013
 Tel: 1-800-715-4396 / (972) 649-6678
 Fax: (972) 649-6689
www.fairviewmicrowave.com
sales@fairviewmicrowave.com

Typical Performance Data

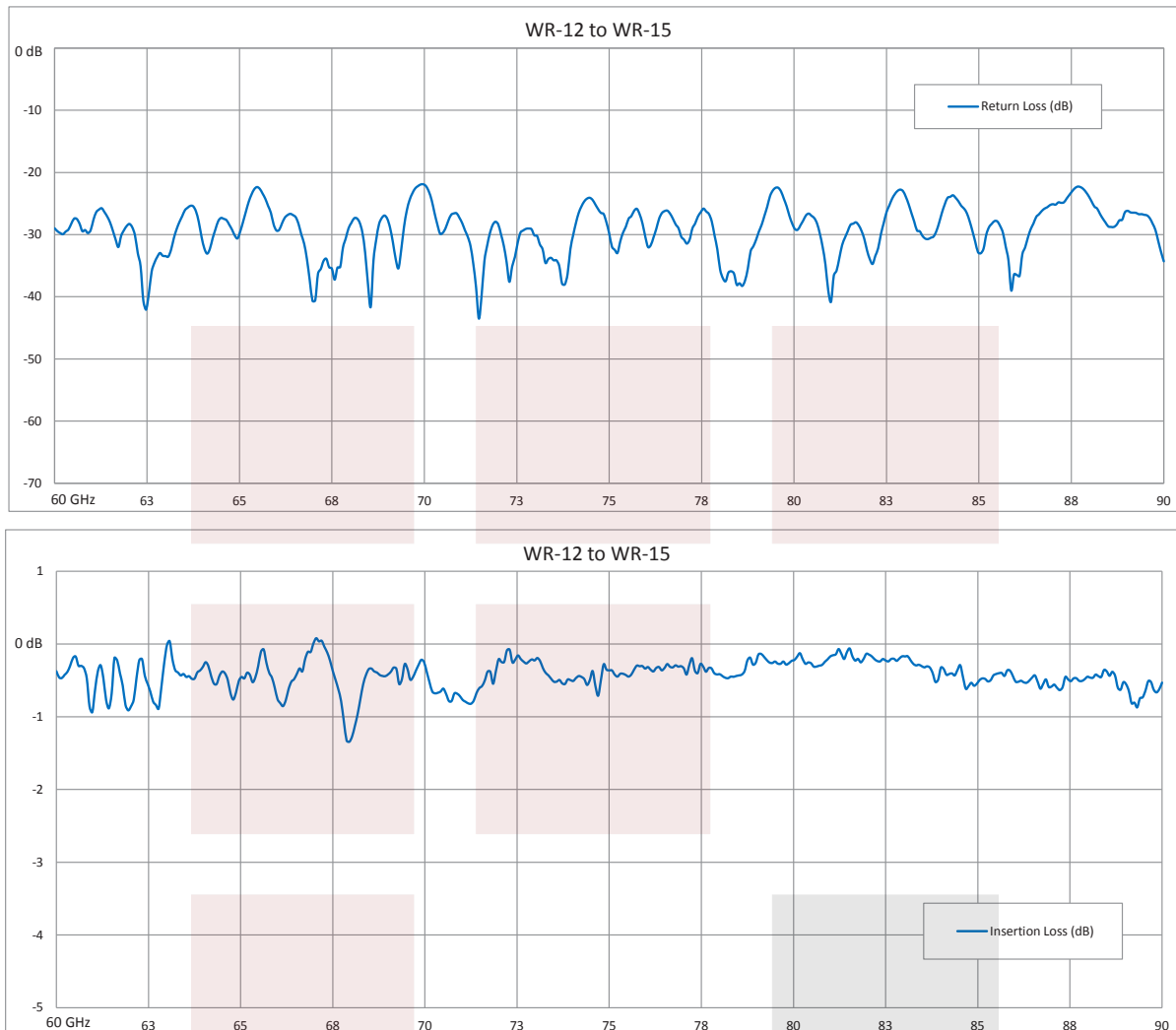

WR-12 to WR-15 Waveguide Transition 1 Inch Length Using UG-387/U to UG-385/U Flange from Fairview Microwave is in-stock and available to ship same-day. All of our RF/microwave products are available off-the-shelf from our ISO 9001:2008 certified facilities in Allen, Texas. Fairview Microwave is RF on-demand.

For additional information on this product, please click the following link: [WR-12 to WR-15 Waveguide Transition 1 Inch Length Using UG-387/U to UG-385/U Flange SMW12TS15001](http://www.fairviewmicrowave.com/wr-12-wr-15-waveguide-transition-smw12ts15001-p.aspx)

URL: <http://www.fairviewmicrowave.com/wr-12-wr-15-waveguide-transition-smw12ts15001-p.aspx>

The information contained in this document is accurate to the best of our knowledge and representative of the part described herein. It may be necessary to make modifications to the part and/or the documentation of the part, in order to implement improvements. Fairview Microwave reserves the right to make such changes as required. Unless otherwise stated, all specifications are nominal. Fairview Microwave does not make any representation or warranty regarding the suitability of the part described herein for any particular purpose, and Fairview Microwave does not assume any liability arising out of the use of any part or documentation.

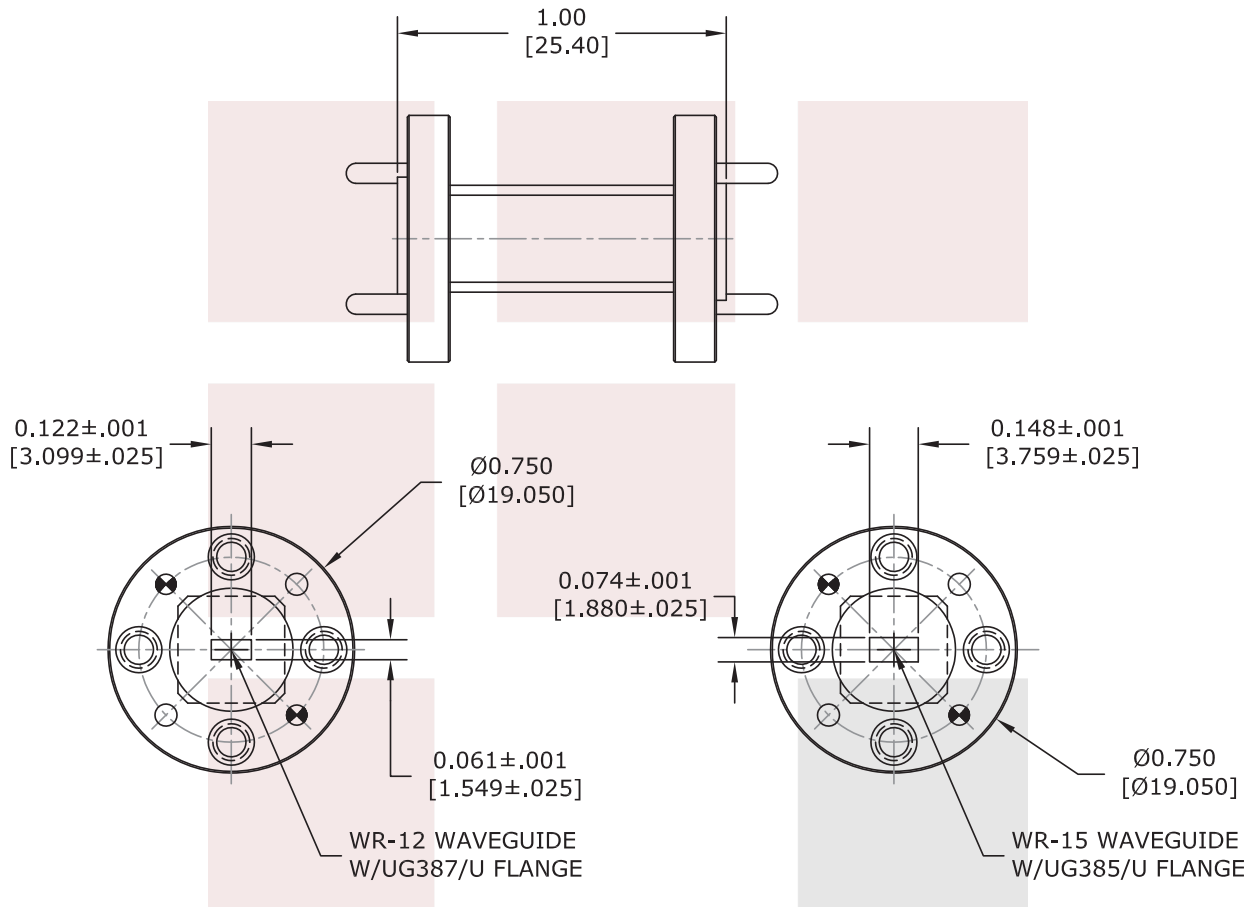

UNLESS OTHERWISE SPECIFIED:
DIMENSIONS ARE IN: inches [mm]
TOLERANCES ARE:
.XX ±.10 [± 2.54]
.XXX ±.005 [± .127]

* THESE DIMENSIONS AND TOLERANCES SUPERSEDE NOTE #1 ON TITLE BLOCK.

FAIRVIEW MICROWAVE INC. ALLEN, TX 75013 WWW.FAIRVIEWMICROWAVE.COM		NOTES: 1. UNLESS OTHERWISE SPECIFIED ALL DIMENSIONS ARE NOMINAL. 2. ALL SPECIFICATIONS ARE SUBJECT TO CHANGE WITHOUT NOTICE AT ANY TIME. 3. DIMENSIONS ARE IN INCHES [mm].			
TITLE WR-12 to WR-15 Waveguide Transition 1 Inch Length Using UG-387/U to UG-385/U Flange		DWG NO SMW12TS15001		CAGE CODE 3FKR5	
CAD FILE	020316	SHEET	SCALE	N/A	SIZE A 2233