

Equalizer

DC-2GHz /1dB,Insertion Loss

TLME-DC2G-7

The TURME-DC2G7 is an equalizer. It is a positive gain slope equalizer designed to pass DC to 2GHz. Equalization can be applied to reduce low pass filtering effects in both RF/microwave and high speed digital systems.

Features:

- Frequency range: DC-2GHz
- Good gain equalization
- Small Size and simple to use
- Excellent return loss

Applications:

- N/A

电气特性 Electrical Characteristics:

参数 Parameter	Min	Typ	Max	单位 Units
频率范围 Frequency range		DC-2		GHz
插损 Insertion Loss@2GHz		1		dB
均衡量 Slope		7		dB
回波损耗 Return Loss		-20		dB
耐受功率 Power Handling		30		dBm
阻抗 Impedance		50		Ohms

机械特性 Mechanical Specifications:

参数 Parameter	指标 Value	单位 Units
输入/输出接口 Input /Output Connector	2.92mm Male/2.92mm Female	
长度 Length	42.2	mm

外形图 Outline Drawing: Unit:mm

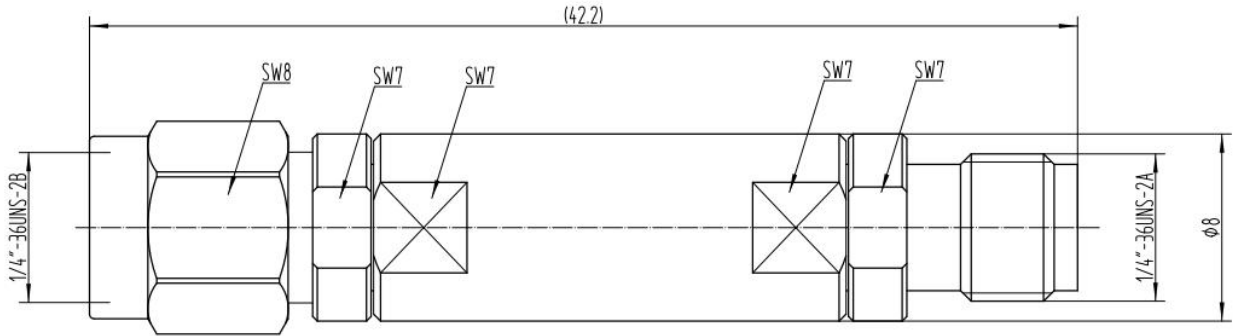

温度环境 Environmental Conditions:

参数 Parameter	Min	Typ	Max	单位 Units
操作温度 Operating Temperature	-55		+125	°C
存储温度 Non-operating Temperature	-65		+150	°C
相对湿度 Relative humidity		95		%
海拔 Altitude	10,000			feet
震动 Shock / Vibration(MIL-STD-810F)	25g rms (15 degree 2KHz) endurance, 1 hour per axis			
冲击 Shock(non operating)	20G for 11msc half sin wave,3 axis both directions			

订货信息 Ordering Information:

标准型号 Base Number	描述 Description	版本号 Revision
TURME-DC2G7	Equalizer, DC-2GHz, Insertion loss:1dB@2GHz	Rev.1.1

典型曲线 Typical Performance Data:

Insertion Loss vs Frequency

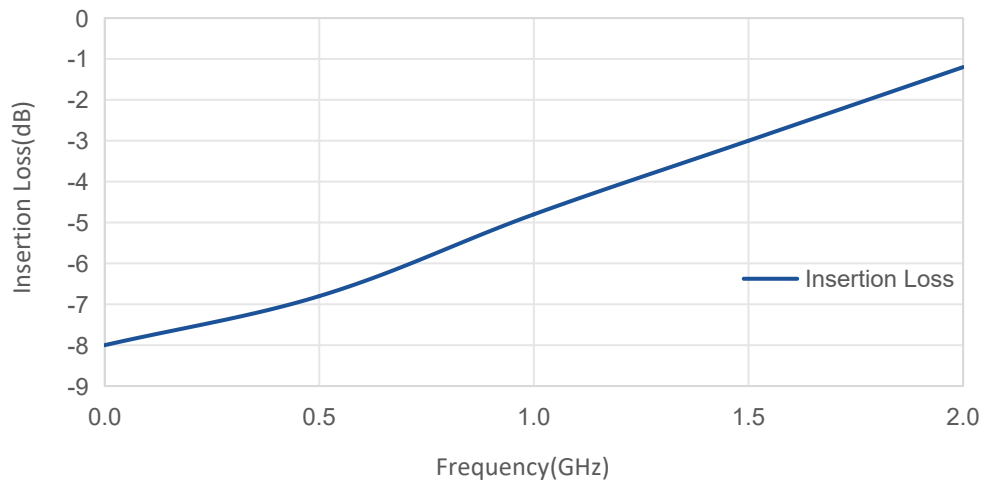

Note: Above data is for ref only, actual data may vary from unit to unit depending on operating environment and other factors like material lots etc.